

SIEMENS

MOTION CONTROL

EMC installation guidelines / basic system requirements

Configuration Manual

Preface

Introduction

1

Safety information

2

Information on planning, design and installation

3

Valid for

- MICROMASTER
- SIMOCRANE
- SIMODRIVE
- SIMOREG
- SIMOTICS
- SIMOTION
- SIMOVERT MASTERDRIVES
- SINAMICS
- SINUMERIK



(PH1), 01/2012

6FC5297-0AD30-0BP3

Legal information

Warning notice system

This manual contains notices you have to observe in order to ensure your personal safety, as well as to prevent damage to property. The notices referring to your personal safety are highlighted in the manual by a safety alert symbol, notices referring only to property damage have no safety alert symbol. These notices shown below are graded according to the degree of danger.

 DANGER
indicates that death or severe personal injury will result if proper precautions are not taken.
 WARNING
indicates that death or severe personal injury may result if proper precautions are not taken.
 CAUTION
with a safety alert symbol, indicates that minor personal injury can result if proper precautions are not taken.
CAUTION
without a safety alert symbol, indicates that property damage can result if proper precautions are not taken.
NOTICE
indicates that an unintended result or situation can occur if the relevant information is not taken into account.

If more than one degree of danger is present, the warning notice representing the highest degree of danger will be used. A notice warning of injury to persons with a safety alert symbol may also include a warning relating to property damage.

Qualified Personnel

The product/system described in this documentation may be operated only by **personnel qualified** for the specific task in accordance with the relevant documentation, in particular its warning notices and safety instructions. Qualified personnel are those who, based on their training and experience, are capable of identifying risks and avoiding potential hazards when working with these products/systems.

Proper use of Siemens products

Note the following:

 WARNING
Siemens products may only be used for the applications described in the catalog and in the relevant technical documentation. If products and components from other manufacturers are used, these must be recommended or approved by Siemens. Proper transport, storage, installation, assembly, commissioning, operation and maintenance are required to ensure that the products operate safely and without any problems. The permissible ambient conditions must be complied with. The information in the relevant documentation must be observed.

Trademarks

All names identified by ® are registered trademarks of Siemens AG. The remaining trademarks in this publication may be trademarks whose use by third parties for their own purposes could violate the rights of the owner.

Disclaimer of Liability

We have reviewed the contents of this publication to ensure consistency with the hardware and software described. Since variance cannot be precluded entirely, we cannot guarantee full consistency. However, the information in this publication is reviewed regularly and any necessary corrections are included in subsequent editions.

Preface

Additional information

Using the following link, you can find information on the topics:

- Ordering documentation / documentation overview
- Additional links to download documents
- Using documentation online (find and search in manuals/information)

<http://www.siemens.com/motioncontrol/docu>

Please send any questions about the technical documentation (e.g. suggestions for improvement, corrections) to the following e-mail address:
docu.motioncontrol@siemens.com

My Documentation Manager

Using the following link, you can find information on how to create your own individual documentation based on Siemens' content and adapt it for your own machine documentation:

<http://www.siemens.com/mdm>

Training

Using the following link, you can find information on SITRAIN - training from Siemens for products, systems and automation engineering solutions:

<http://www.siemens.com/sitrain>

FAQs

You can find Frequently Asked Questions in the Service&Support pages under **Product Support**:

<http://support.automation.siemens.com>

Target group

This documentation is intended for machine manufacturers, commissioning engineers and service personnel who use the drive system / control system.

Benefits

This manual provides all the information, procedures and operator actions required for configuring and service.

Technical support

Country-specific contact information for technical support (hotline) can be found on the Internet at (<http://www.automation.siemens.com/partner>)

- Selection [country]
- Selection [service] = technical support

or send us your technical request directly
via (<http://www.siemens.com/automation/support-request>)

EC Declarations of Conformity

The EC Declaration of Conformity for the EMC Directive can be found on the Internet at:

<http://support.automation.siemens.com>

Enter there the number **15257461** as a search term or contact your local Siemens office.

The EC Declaration of Conformity for the Low-Voltage Directive can be found on the Internet at:

<http://support.automation.siemens.com>

Enter there the number **22383669** as a search term.

EMC limit values in South Korea

The applicable EMC limit values for Korea correspond to the limit values of the EMC product standard for variable-speed electric drives EN 61800-3 of category C2 or the limit value class A, Group 1 to EN 55011. With suitable additional measures the limit values according to category C2 or to limit value class A, Group 1, are complied with. Additional measures, such as the use of an additional RFI suppression filter (EMC filter), may be necessary.

Please note that the final statement on compliance with the standard is given by the respective label attached to the individual unit.

Spare parts

You can find spare parts on the Internet at:

<http://support.automation.siemens.com/WW/view/en/16612315>

Test certificates

The Safety Integrated functions of SINAMICS components are generally certified by independent institutes. An up-to-date list of already certified components is available on request from your local Siemens office. If you have any questions relating to certifications that have not yet been completed, please ask your Siemens contact.

ESD information

 CAUTION
<p>Electrostatic sensitive devices (ESDs) are individual components, integrated circuits, or boards that may be damaged by either electrostatic fields or electrostatic discharge.</p> <p>Regulations for handling ESD components:</p> <p>When handling electronic components, ensure that personnel, workplaces, and packaging are well grounded!</p> <p>Personnel in ESD areas with conductive flooring may only handle electronic components if:</p> <ul style="list-style-type: none">• They are grounded with an ESD wrist band• They are wearing ESD shoes or ESD shoe grounding straps <p>Electronic components should be touched only when this is unavoidable. They must only be handled on the front panel or, in the case of printed circuit boards, at the edge.</p> <p>Electronic components must not be brought into contact with plastics or clothing made of artificial fibers.</p> <p>Electronic components must only be placed on conductive surfaces (work surfaces with ESD surface, conductive ESD foam, ESD packing bag, ESD transport container).</p> <p>Electronic components must not be placed near display units, monitors or televisions with cathode ray tubes (minimum distance from the screen > 10 cm).</p> <p>Measurements may only be taken on boards when the measuring device is grounded (via protective conductors, for example) or the measuring probe is briefly discharged before measurements are taken with an isolated measuring device (for example, touching a bare metal housing).</p>

 DANGER
<p>Electrical, magnetic, and electromagnetic fields (EMF) occurring during operation can pose a danger to people in the direct vicinity of the product, especially people with pacemakers, implants, or similar.</p> <p>The relevant directives and standards must be observed by the machine and plant operators and people present in the vicinity of the product. These are, for example, EMF Directive 2004/40/EEC and standards EN 12198-1 to -3 applying to the European Economic Area (EEA) and in Germany the accident prevention regulation BGV 11 and the associated rule BGR 11 "Electromagnetic fields" from the German employer's liability accident insurance association.</p> <p>These state that a hazard analysis must be drawn up for every workplace, from which measures for reducing dangers and their impact on people are derived and applied, and exposure and danger zones are defined and observed.</p> <p>The relevant safety notes in each chapter must be observed.</p>

General safety guidelines

 **DANGER**

Commissioning is absolutely prohibited until it has been completely ensured that the machine, in which the components described here are to be installed, is in full compliance with the provisions of the EC Machinery Directive.

The installation, commissioning and maintenance must only be performed by appropriately qualified personnel.

The personnel must take into account the information provided in the technical customer documentation for the product, and be familiar with and observe the specified danger and warning notices.

Operational electrical equipment and motors have parts and components which are at hazardous voltage levels that may cause serious injuries or death when touched.

All work on the electrical system must be carried out when the system has been disconnected from the power supply.

 **WARNING**

The successful and safe operation is dependent on proper transportation, storage, installation and assembly, as well as on careful operation and maintenance.

The details in the catalogs and proposals also apply to the design of special equipment versions.

In addition to the danger and warning information provided in the technical customer documentation, the applicable national, local, and system-specific regulations and requirements must be taken into account.

According to EN 61800-5-1 and UL 508, only safely isolated protective extra low voltages may be connected to any of the connections or terminals on the electronics modules.

 **DANGER**



Using protection against direct contact via DVC A (PELV) is permissible only in areas with equipotential bonding and in dry rooms indoors. If these conditions are not met, other protective measures with regard to electric shock must be taken, e.g. touch protection.

CAUTION

Operating the equipment in the immediate vicinity (< 1.5 m) of mobile telephones with a transmitting power of > 1 W may cause the devices to malfunction.

Explanation of symbols

Table 1 Symbols

Symbol	Meaning
	Protective earth (PE)
	Ground (e.g. M 24 V)
	Functional ground Equipotential bonding

Residual risks of power drive systems

The control and drive components of a power drive system (PDS) are approved for industrial and commercial use in industrial line supplies. Their use in public line supplies requires a different configuration and/or additional measures.

These components may only be operated in closed housings or in higher-level control cabinets with protective covers that are closed, and when all of the protective devices are used.

These components may only be handled by qualified and trained technical personnel who are knowledgeable and observe all of the safety information and instructions on the components and in the associated technical user documentation.

When performing a risk assessment of the machine in accordance with the EU Machinery Directive, the machine manufacturer must consider the following residual risks associated with the control and drive components of a power drive system (PDS).

Unintentional movements of driven machine components during commissioning, operation, maintenance, and repairs caused by, for example:

- Hardware defects and/or software errors in the sensors, controllers, actuators, and connection technology
- Response times of the controller and drive
- Operating and/or ambient conditions outside of the specification
- Condensation/conductive contamination
- Parameterization, programming, cabling, and installation errors
- Use of radio devices / cellular phones in the immediate vicinity of the controller
- External influences/damages

1. Exceptional temperatures as well as emissions of light, noise, particles, or gas caused by, for example:
 - Component malfunctions
 - Software errors
 - Operating and/or ambient conditions outside of the specification
 - External influences/damages
2. Shock-hazard voltages caused by, for example:
 - Component malfunctions
 - Influence of electrostatic charging
 - Induction of voltages in moving motors
 - Operating and/or ambient conditions outside of the specification
 - Condensation/conductive contamination
 - External influences/damages
3. Electrical, magnetic and electromagnetic fields generated in operation that can pose a risk to people with a pacemaker, implants or metal replacement joints, etc. if they are too close.
4. Release of environmental pollutants or emissions as a result of improper operation of the system and/or failure to dispose of components safely and correctly.

Note

Functional safety of the components

The components must be protected against conductive contamination (e.g. by installing them in a control cabinet with degree of protection IP54 in accordance with EN 60529).

Assuming that conductive contamination at the installation site can definitely be excluded, a lower degree of cabinet protection may be permitted.

For more information about residual risks of the components in a power drive system, see the relevant chapters in the technical user documentation.

Internal note

The review of the EMC installation guidelines can be found under Review Number 8101.

Table of contents

	Preface	3
1	Introduction	11
2	Safety information	13
3	Information on planning, design and installation	15
3.1	Planning	15
3.2	Application environments for drive systems	15
3.3	EMC-zone concept	16
3.4	Openings in the housing, e.g. ventilation openings	18
3.5	Equipotential bonding	18
3.5.1	Equipotential bonding within a control cabinet	19
3.5.2	Equipotential bonding between several cabinet elements	20
3.5.3	Equipotential bonding inside the machine/plant	20
3.5.4	Equipotential bonding of components to moving parts/slides	22
3.6	Cables	22
3.6.1	General	22
3.6.2	Shielded cables	23
3.6.2.1	Plug connections for shielded cables	24
3.6.3	Cables in the power line	25
3.6.3.1	Bundling, parallel connection of cables	25
3.6.3.2	The motor cable shield connection at the motor modules	25
3.6.3.3	Shield connection of the motor cable to the motor terminal box	26
3.6.3.4	Shield connection for cables with connector	26
3.6.3.5	Protective conductor in the motor cables (green/yellow)	26
3.6.3.6	The last meter to the motor	26
3.6.3.7	DC-link connection, braking resistor	26
3.6.3.8	Cable lengths in the power line	26
3.6.4	Brake cables	27
3.6.5	Encoder cables	27
3.6.5.1	Encoder cables with plug connectors	27
3.6.5.2	DRIVE-CLiQ encoder connections	27
3.6.5.3	Cable lengths for encoders	27
3.6.6	DRIVE-CLiQ connections	27
3.6.7	Field bus	28
3.6.7.1	PROFIBUS, PROFINET	28
3.6.8	Analog signals	29
3.6.9	Examples of shield connections	29
3.7	Laying cables on cable racks/routes at the plant	29
3.8	Connection to the line supply	31
3.8.1	Drive line filter, cabinet line filter	31
3.8.2	Drive line filter arrangement, line reactor, drive group	32

3.9	Miscellaneous	33
3.9.1	Wiring of coils	33
3.9.2	Bearing currents	33

Introduction

EMC (electromagnetic compatibility) means that the devices function satisfactorily without interfering with other devices and without being disrupted by other devices. This is true when the emitted interference (emission level) and the interference immunity are matched with each other.

EMC emitted interference and interference immunity are regulated worldwide by standards, guidelines or laws.

In order to comply with the regulated limit values and to ensure the function, the measures described below must be observed as minimum.

In the case of devices that are supplied ready to use, it normally suffices to install and operate them in accordance with the manufacturer's documentation in order to observe the EMC limit values and to achieve a satisfactory function.

Drive systems, however, are usually supplied in the form of components, such as line filters, line reactors, converters, motors and cables. The fast switching of the power semiconductors are major sources of interference to drive systems. In order to observe the EMC limit values and to achieve a satisfactory function, the specifications of the manufacturer documentation must be observed for the assembly and installation.

We strongly recommend that all components originate from the same manufacturer and are combined in accordance with the catalog or configuration guidelines because they have been tested in example constructions. If, however, the user combines components from different manufacturers, the user is solely responsible for the observance of the EMC limit values and the function of the plant.

Provided the following information is observed for the design of the components to form a system, it can be assumed that the EMC limit values are met and a satisfactory function achieved.

It is essential to follow the safety instructions given in the device-specific technical user documentation under all circumstances.

The binding document for configuring the respective device types is always the device-specific technical user documentation.

Certificates, declarations of conformity, test certificates, such as CE, UL, Safety Integrated, etc., are valid only when the components described in the associated catalogs and configuration guides are used, and installed in accordance with the configuring guidelines and used properly. In other cases, such documents must be prepared again by the vendor of these products.

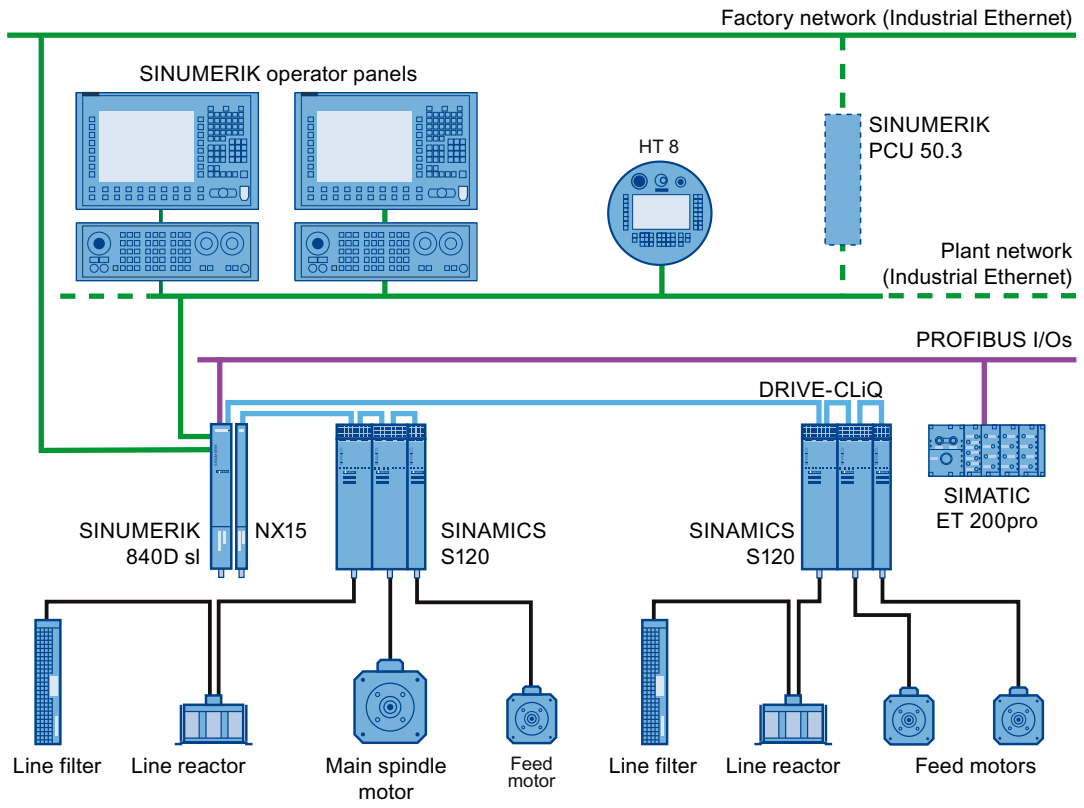

Figure 1-1 Example of an equipment item (schematic)

Safety information

CAUTION

The laying of cables on ventilation grilles is not permitted. This would considerably impede the heat dissipation of the devices, in particular for narrow modules. Moreover, the resulting high exhaust air temperatures can damage the cable insulation.

Power cables must be routed to the component connections so that the air supply is not obstructed more than necessary. To achieve this, the cables should preferably be laid vertical.

Information on planning, design and installation

This documentation contains general information and examples for the EMC-compliant design of controller and drive components in the control cabinet.

This installation guideline covers the best possible electromagnetic compatibility for the design of controller and drive components and informs about points that must be considered for the proper design of the drive system.

If these rules are not observed, malfunctions or faults in other devices and consequently potential failure must be expected.

Note

Cables in machines and control cabinets are subject to high requirements, such as bending strength in ground cables, highly dynamic movements of motors, resistance to cutting oils and EMC properties. For this reason, only those cables that have been released for these applications, e.g. MOTION-CONNECT cables, must be used. Especially for machines with functional safety, the use of such cables is necessary.

3.1 Planning

The achieving of the EMC at a plant, machine or control cabinet requires careful planning. The requirements result from:

- EMC requirements appropriate for the environment, see Application environments for drive systems (Page 15)
- EMC zone concept, see EMC-zone concept (Page 16)
- Equipotential bonding, see Equipotential bonding (Page 18)

3.2 Application environments for drive systems

The permitted emission level is at a low level in the first environment (residential). For this reason, devices for use in the first environment must have a low noise emission, but require only a relatively small interference immunity.

The permitted emission level is at a high level in the second environment (industrial area). Devices for use in the second environment may have a relatively high emitted interference, but also require a high level of interference immunity.

3.3 EMC-zone concept

Table 3- 1 Environments and categories in accordance with EMC product standard IEC 61800-3

Variable-speed PDS drive system				
Environment	1. Environment (residential and commercial areas) (public grid)		2. Environment (industrial area) (industrial network decoupled with an isolating transformer)	
Category	C1 ¹⁾	C2 ²⁾	C3 ³⁾	C4 ⁴⁾
Voltage, current	< 1,000 V			≥ 1,000 V or ≥ 400 A
Line system	TN, TT			TN, TT, IT
Expert	No request	Installation and commissioning must be performed by authorized personnel.		

- 1) No products are on offer for category C1.
- 2) Drive systems installed by qualified personnel can be used in the first environment category C2 in accordance with EMC product standard IEC 61800-3.
- 3) The drive systems described in this document with the associated filters in accordance with EMC product standard IEC 61800-3 can be used in the second environment category C3.
- 4) To ensure the EMC in the category C4, it is necessary that the plant manufacturer and the plant operators agree an EMC plan that specifies individual, plant-specific measures. If prescribed by the product description, drive systems can also be used in non-grounded systems (IT systems) in accordance with EMC product standard IEC 61800-3.

3.3 EMC-zone concept

Interference suppression measures within the plant or the control cabinet are easiest to implement and most cost-effectively by installing interference sources and sinks physically separated from each other. This separation must already be taken into consideration during the planning.

First, it must be decided for each used device whether it is a potential interference source or sink.

- Typical interference sources are, for example, frequency converters, braking modules*, switched-mode power supplies, coils for contactors.
- Typical interference sinks are, for example, automation devices, encoders and sensors as well as their evaluation electronics.
- The entire area of the plant or the control cabinet is then divided into EMC zones and the devices assigned to the zones. The following example explains the zone concept in greater detail.

* Depending on the device series, terms such as braking chopper, pulsed resistor module or similar are also in use.

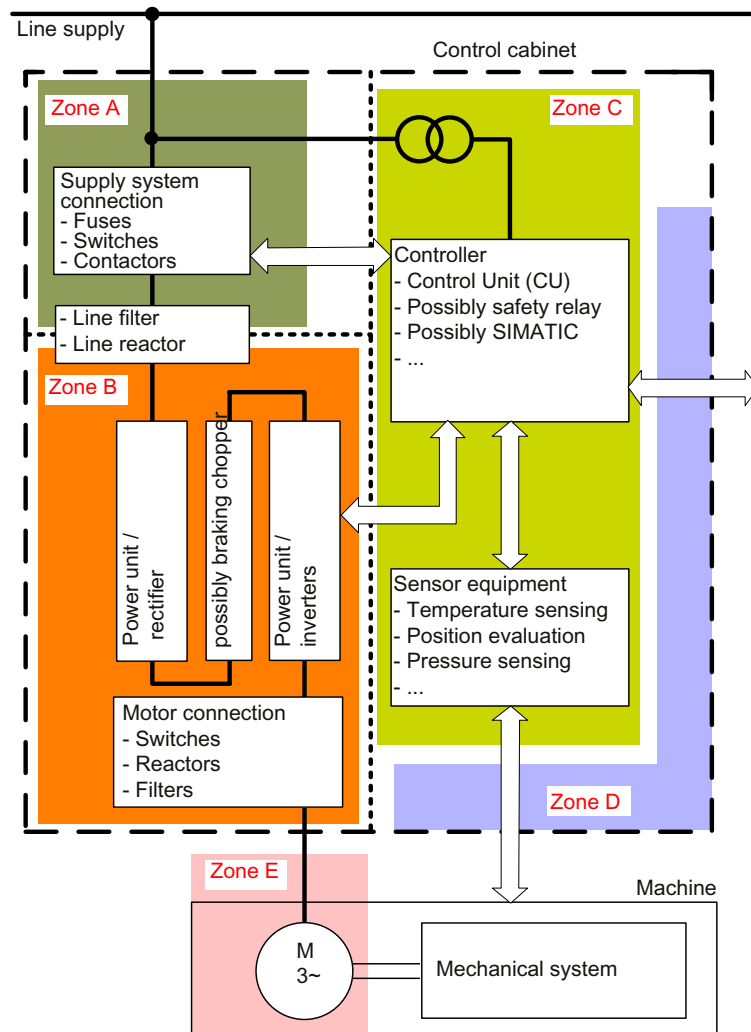

----- Grounded metal partition

Zone A System connection

The limit values for the conducted interference emission and interference immunity must be observed

Zone B Power electronics

Interference sources: Converters consisting of rectifiers, possibly braking choppers, inverters and possibly motor-side reactors and filters

Zone C Controller and sensors

Interference sinks: Sensitive open-loop and closed-loop control electronics and sensors

Zone D Signal interfaces for the I/O

The limit values for the interference immunity must be observed

Zone E Motor and motor cable

Interference sources

Figure 3-1 Classification of the control cabinet or the drive system into EMC zones

3.4 Openings in the housing, e.g. ventilation openings

Specific requirements regarding the interference emission and the interference immunity apply within each zone. The zones must be decoupled electromagnetically. This decoupling can, for example, be achieved with large physical separations (approx. 20 cm). Better and space-saving is decoupling using separate metal enclosures or large metal partitions.

Cables of different zones must be separated and must not be laid in shared cable harnesses or cable ducts. Where necessary, filters and/or coupler blocks must be deployed at the zone interfaces. Coupler blocks with electrical isolation can effectively prevent the interference propagation between the zones.

All communication and signal cables that exit the control cabinet must be shielded. Additional isolation amplifiers must be used for longer analog signal cables.

3.4 Openings in the housing, e.g. ventilation openings

Ventilation holes, inspection windows, operator controls, etc., impair the shielding effect of the control cabinet. Each opening half the size of the wavelength λ of the interference frequency acts as an antenna and radiates electromagnetic fields. In practice, the slit lengths should be less than $\lambda/20$. The following openings have proven themselves:

- In the first environment, openings with a maximum diameter of 30 mm
- In the second environment, openings with a maximum diameter of 100 mm

Openings with a diameter larger than 100 mm must be covered with a metal hood. It must have a good metallic-conducting contact with the cabinet panel.

3.5 Equipotential bonding

To ensure the problem-free interaction of the components in a complex system, a good equipotential bonding is necessary that acts effectively for technical frequencies and high frequencies in the area above 10 MHz.

To achieve this, all metallic parts must have a large surface-area contact with each other and so form an equipotential area.

This also prevents shields applied on both sides from being damaged or burnt due to high equalizing currents or components from being subjected to interference, damaged or destroyed because of an excessive voltage difference.

Signal cables to stations outside this equipotential area must be equipped with electrically-isolating coupling blocks.

3.5.1 Equipotential bonding within a control cabinet

The equipotential bonding within a control-cabinet is achieved by connecting all metallic parts to one another at as many positions as possible over a large area, such as control-cabinet panels or stays. Cabinet doors should be connected to the stays or side panels with the shortest-possible copper ribbons at least at the top and bottom. The housing of the devices and components installed in the cabinet element (e.g. converters, line filters, control units, terminal modules, sensor modules, etc.) must be connected with each other using a good-conducting (galvanized) mounting plate over a large surface area.

This mounting plate must have a large surface area electrically-conductive connection with the cabinet frame, PE or shield buses of the cabinet element.

Painted control-cabinet panels, mounting plates or mounting equipment with a small mounting footprint do not fully satisfy this requirement. If painted control-cabinet panels or mounting plates need to be used, an adequately-good contact must be ensured. To do this, the cable glands must be freed of paint during the installation or contact washers used. Corrosion protection is necessary, e.g. painting after installation.

If several mounting plates are connected with each other using cables or ribbon wires, the connection must be made close to the signal or power cable (minimization of the enclosed area).

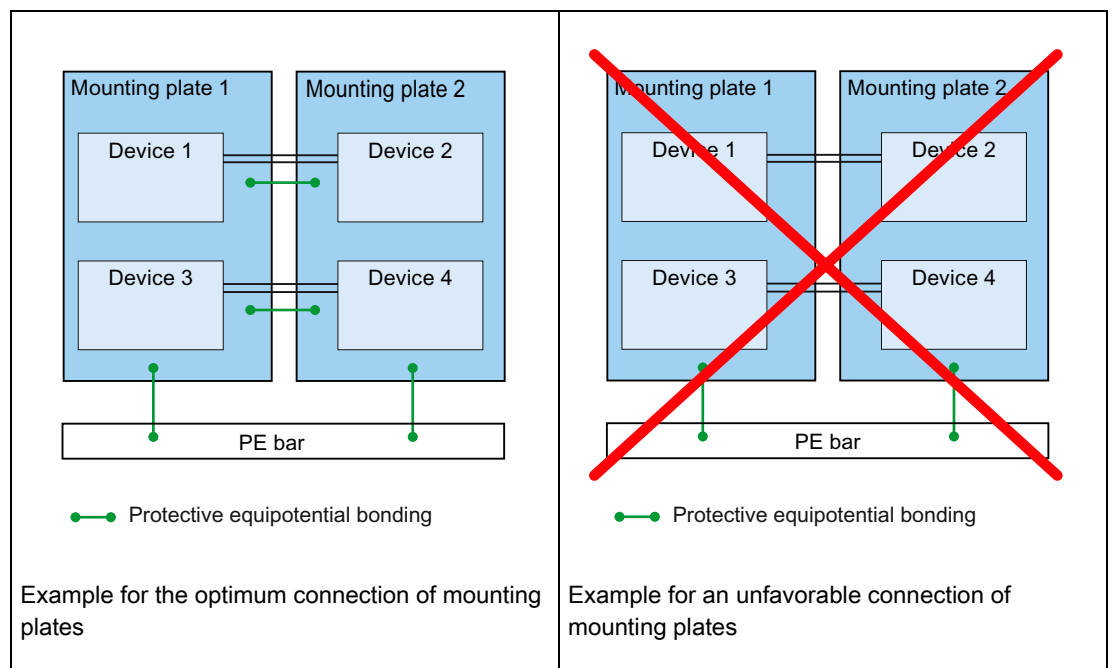

The larger surface area of ribbon connections makes them more favorable than round connections with regard to EMC.

3.5 Equipotential bonding



Figure 3-2 Example for the connection with braided-copper ribbon

3.5.2 Equipotential bonding between several cabinet elements

The equipotential bonding between several cabinet elements for larger cabinet units is made with an interconnecting PE bar that passes through all these cabinet elements. In addition, the frames of the individual cabinet elements are screwed together several times with good conductivity ensured through the use of contact washers. If very long rows of cabinets are installed back-to-back, the two PE bars must be connected with each as often as possible (recommended value: ten screw connections per cabinet element).

3.5.3 Equipotential bonding inside the machine/plant

The equipotential bonding within the machine/plant for technical frequencies is made by connecting all the electrical and mechanical drive components (transformer, control cabinet, motor, gear unit and driven machine) to the grounding system. These connections are made with standard, heavy-duty PE conductors. For high frequencies, the equipotential bonding is made using the shields of the motor cables to all components of the drive train (motor, gear unit and driven machine).

The following diagram illustrates all grounding and high-frequency equipotential bonding measures using the example of a typical high-power installation comprising several SINAMICS S120 Cabinet Modules.

Note

Compared with the shown rod grounding, the mesh grounding provides better results.

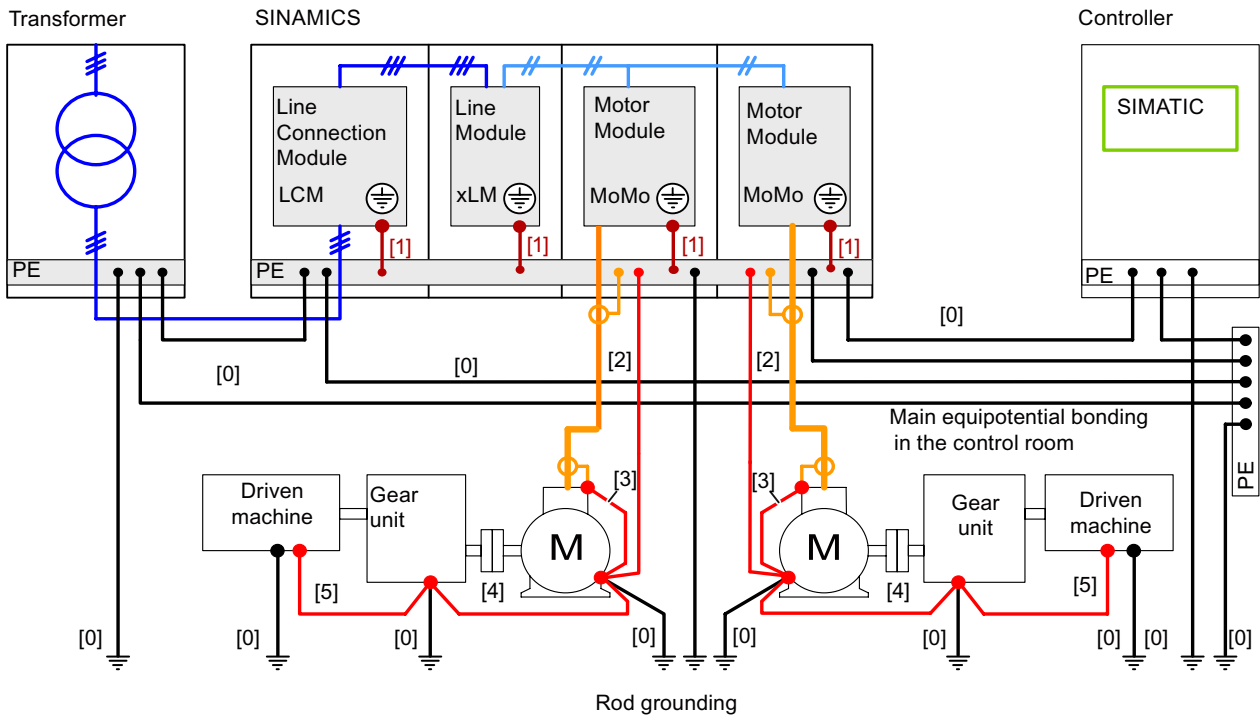

- [0] The ground connections shown black form the conventional grounding system for the drive components. They are made with standard, heavy-duty PE conductors without special high-frequency properties and ensure low-frequency equipotential bonding as well as protection against injury.
- [1] The connections shown dark red inside the control cabinets provide good conductivity for high-frequency protection between the metal housings of the integrated converter components and the PE bar and EMC shield bus of the cabinet. These internal connections can be established over the greatest possible surface area using the metallic construction of the cabinet unit, whereby the contact surfaces must be bare metal and have a minimum cross-section of several cm² at each contact point. Alternatively, these connections can be established by means of short, finely-stranded, braided copper wires with a large cross-section (> 95 mm²).
- [2] The shields of the motor cables shown in orange provide the high-frequency equipotential bonding between the inverters or motor modules and the motor terminal boxes. The finely stranded, braided copper cables shown in red can be routed in parallel with these when cables with poor high-frequency properties are used or in installations with inferior grounding systems.
- [3], [4], [5] The connections shown in red provide a good-conducting high-frequency connection for the motor terminal box or the gear unit and the driven machine bond to the motor housing.

Figure 3-3 Grounding and high-frequency equipotential-bonding measures for equipotential bonding in the drive system via ground

3.6 Cables

3.5.4 Equipotential bonding of components to moving parts/slides

When components are mounted on moving parts/slides, an additional equipotential-bonding conductor (at least 10 mm²) should, if possible, be laid in parallel and near the cable (bundled). This equipotential-bonding conductor must be connected as close as possible to the component on the slide and directly at the PE connection for the associated module on the cabinet.

Note

The cables must be suitable for trailing.

3.6 Cables

3.6.1 General

Power and signal cables, even shielded, must always be routed separately. For this purpose, it is practical to arrange the various cables according to cable groups. Cables belonging to a group can be combined in a bundle. The various cable groups must be routed with the necessary clearance between them. A minimum clearance of 20 cm has proven itself in practice. As an alternative, shielding plates with the appropriate contacts at several locations can be used between the cable bundles.

In order to reduce crosstalk, all cables must be laid as close as possible to the (grounded) structural parts connected to the cabinet ground. These are, for example, mounting plates or frame parts of the cabinet.

In order to minimize the antenna effect, all cables should be kept as short as possible.

Although signal and power cables may cross each other (if absolutely necessary), they must never be routed close to each other over longer distances.

Signal cables must be routed with a minimum clearance of 20 cm from strong magnetic fields (motors, transformers). Alternatively, shield plates with the appropriate contacts at several locations along their length can be used to provide the appropriate clearance.

CAUTION
Cables for the 24 V supply should be treated just like signal cables. Adequate bending radiuses of the signal and power cables must be ensured.

! WARNING

Capacitive coupling causes charging. To discharge these charges, at least one end of the unused conductors for unshielded and shielded cables and their shields must be placed on a grounded housing potential. Non-compliance may cause potentially fatal touch voltages to develop at non-grounded insulated conductors and shielding.

3.6.2 Shielded cables

To achieve the smallest possible transfer resistances in the high-frequency area, cable shields must always be connected at both ends with the largest possible surface area, if possible using spring-loaded elements that enclose the shield.

The shield must be uninterrupted.

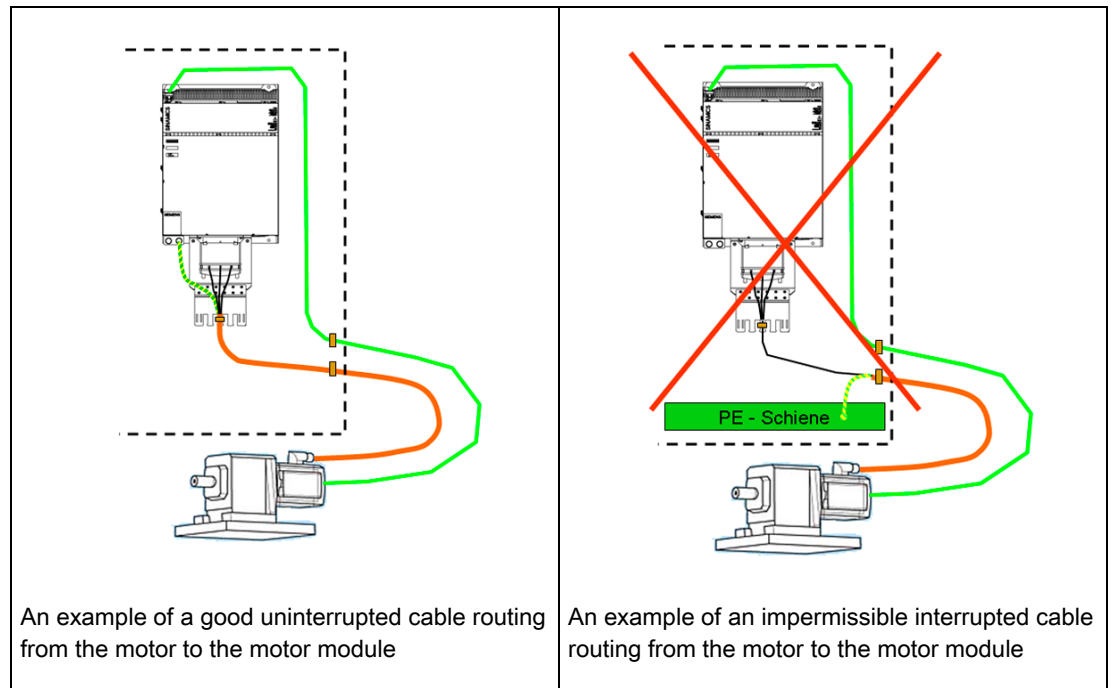

If a break in the cable cannot be avoided, a bridging of the shields such as that shown in the figure below must be provided.

3.6 Cables

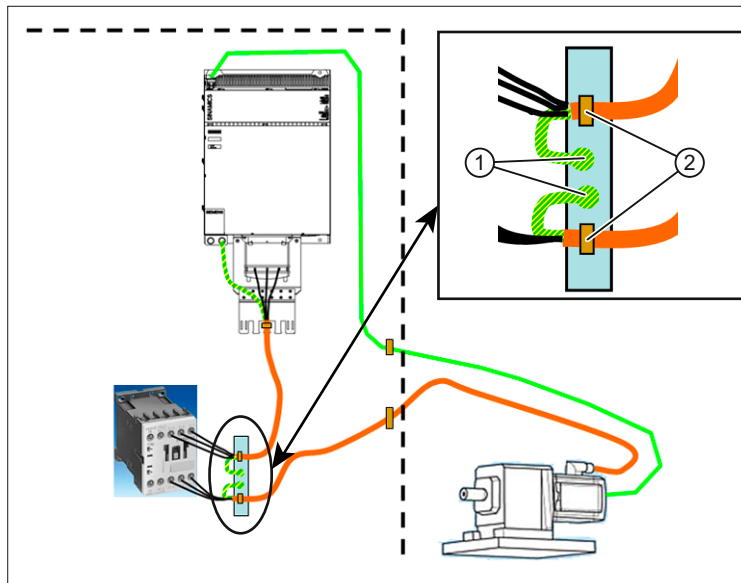

- ① Protective conductor
- ② Shield connection

Figure 3-4 Example of good shield bridging with braided-copper ribbon

Braided shields should be favored. Foil shields should be avoided because their current-carrying capacity is smaller and so the shields can be damaged.

Shield connections may not also serve as strain relief. The strain relief must be implemented separately so that the shield connection is free from tensile forces.

As an alternative to the shielding inside control cabinets, measures are permitted that achieve similar results as shielding, such as routing behind mounting plates or in metal cable channels, suitable clearances, etc.

3.6.2.1 Plug connections for shielded cables

If cable shields are connected via connector enclosures, continuous metallic contact in the connector must be ensured. Metalized plastic is not suitable in plants with converters for providing sufficient contact over the plant service life because the metallic coating will be abraded by vibrations or eroded by the shield current. If such connectors or connectors with an unknown internal design are used, the shield must also be connected close to the connector; see Figure 3-7 Examples of good types of shield connection (Page 29).

3.6.3 Cables in the power line

Power cables in converter systems, in particular motor cables, are some of the largest generators of interference signals. For this reason, all cables from the output of the drive line filter must be laid twisted/bundled and shielded without interruption to the motor. Experience has shown that short connections under 1 m within the control cabinet can be laid twisted/bundled without shield, e.g. the connection filter to the reactor, reactor to the infeed DC-link connections. The information from Section Drive line filter arrangement, line reactor, drive group (Page 32) must also be observed.

3.6.3.1 Bundling, parallel connection of cables

For the routing of three-phase systems using single-core cables (e.g. unshielded power supply cables), the three phases L1, L2 and L3 must be bundled symmetrically and so minimize the magnetic leakage fields. This is true even when high currents mean several parallel single-core cables must be laid for each phase of a three-phase system. The following diagram shows an example of this using a three-phase system with two parallel single-core cables per phase:

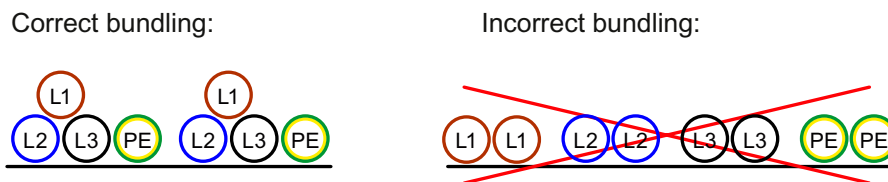

Figure 3-5 Bundling of cables

When more than one motor cable is routed in parallel, note that each individual motor cable must contain all three conductors of the three-phase system. This helps to minimize the magnetic leakage fields and thus also the magnetic interference of other loads.

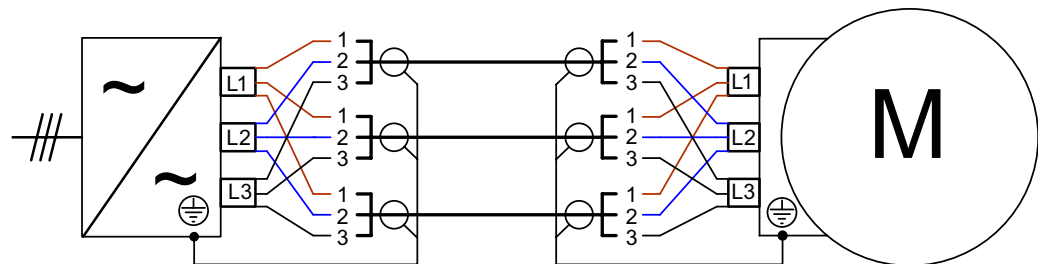

Figure 3-6 Example of three motor cables routed in parallel

3.6.3.2 The motor cable shield connection at the motor modules

The provided shield connections must be used at the motor modules for built-in units. If this cannot be done due to space limitations, the shield must be connected to the mounting plate as close as possible to the motor modules. The shield is connected to the central grounding bar for cabinet units.

3.6 Cables

3.6.3.3 Shield connection of the motor cable to the motor terminal box

To ensure a large-area shield connection, cable glands with EMC inserts must be used on the terminal box, e.g. PG glands. If space requirements mean this is not possible, the shield must be connected as close as possible to the motor housing; see for example Figure 3-7 Examples of good types of shield connection (Page 29).

3.6.3.4 Shield connection for cables with connector

The shield must be connected in the connector at the motor and converter side as described by the connector manufacturer.

3.6.3.5 Protective conductor in the motor cables (green/yellow)

The protective conductor included in the motor cables must be connected directly to the motor module at the PE connection for the cabinet for built-in units. For cabinet units, the connection is made to the central grounding bar. The protective conductor must be connected at the provided PE connection in the connector or in the terminal box at the motor.

3.6.3.6 The last meter to the motor

The position of the connector means the required distances of 20 cm between the motor and encoder cable cannot always be observed on the motor.

Experience has shown that a bundling of motor and encoder cables for mechanical reasons is possible for the last meter to the motor.

3.6.3.7 DC-link connection, braking resistor

If the DC link is further connected to other groups, an equalizing conductor with the two cables must be provided. This must be connected to the motor modules at the provided connections. The three cables must be twisted or be bundled. For lengths exceeding approx. 1 m, a shield instead of the equipotential conductor should be provided. This must be connected at both ends at the provided connections or, for lack of space, at the mounting plates near the drive groups.

The same requirements apply to the cable for the braking resistor.

3.6.3.8 Cable lengths in the power line

If the permissible total cable length is exceeded, the increased shield currents can cause additional losses in the line filter, the line reactor, the infeed module and motor modules or saturation in the line filter, which then become ineffective. This leads to an overheating of the components and thus failures or a reduction of the service life. Information about maximum permissible cable lengths is contained in the device-specific technical user documentation.

3.6.4 Brake cables

Cables for brakes must be shielded. If the brake cables are combined with the motor cables in a common cable, the twisted motor cores with the protective conductor must be routed in a common shield and the twisted brake cores in another separate shield.

The same requirements apply to the shield connection as for the motor cables. See Section The motor cable shield connection at the motor modules (Page 25).

Note

Wiring; see Section Wiring of coils (Page 33).

3.6.5 Encoder cables

Encoders and encoder cables are some of the most sensitive parts of the equipment. In this case, faulty signals, for example in machine tools, can cause surface flaws or sporadic errors of the machine. For double-shielded encoder cables, whereas the outer shield must be connected at both ends, the inner shield is connected at only one side to the drive group.

3.6.5.1 Encoder cables with plug connectors

The shield is usually connected at the connector. When particularly high requirements apply, such as an environment with very high EMC levels, another connection close to the connector is recommended.

3.6.5.2 DRIVE-CLiQ encoder connections

The shield contacting of the DRIVE-CLiQ encoder cables is made at the connector.

3.6.5.3 Cable lengths for encoders

Maximum cable lengths appropriate for the encoder must be observed. Details can be taken from the device-specific technical user documentation.

3.6.6 DRIVE-CLiQ connections

The shield contacting of the DRIVE-CLiQ connections between the components of the drive group is made at the connectors.

The different connector types (integrated 24 V supply) means the use of commercially available Ethernet cables is not permitted.

3.6 Cables

The maximum total cable length for DRIVE-CLiQ is 100 m.

Note

Depending on the used cable type, the cable lengths may be shorter.

3.6.7 Field bus

Field buses must be particularly resistant to faults. To achieve this robustness, the following points according to the manufacturer's instructions of the connected bus components must be observed:

- Sufficient distance from the power cables
- Shield connection to the bus components
- Shield connection at the control cabinet input
- Equipotential bonding

3.6.7.1 PROFIBUS, PROFINET

- The minimum distance between PROFIBUS or PROFINET cables to power cables is 20 cm.
- The shield connection to the PROFIBUS or PROFINET components is implemented at the plug connector. If the component is not mounted on a metal mounting plate, an additional equipotential bonding conductor with 4 mm² cross-section must be laid for the protective equipotential bonding.
- The shield connection at the control cabinet inlet is necessary in order to comply with the immission limit values must be observed in the first environment. The shield connection is recommended for operation in the second environment.
- For PROFIBUS or PROFINET connections between different buildings or parts of buildings, an equipotential bonding must be laid parallel to the PROFIBUS or PROFINET cable.

The following minimum cross-sections according to IEC 60364-5-54 are required:

- Copper: 6 mm²
- Aluminum: 16 mm²
- Steel: 50 mm²

For further information, see under

(http://www.profibus.com/fileadmin/media/wbt/WBT_Assembly_V10_Dec06/en/Seiten/0_1_Vorwort.html)

3.6.8 Analog signals

The shields of cables for analog signals must be connected on both sides, see Figure 3-7 Examples of good types of shield connection (Page 29). A good equipotential bonding between output and input is required.

3.6.9 Examples of shield connections

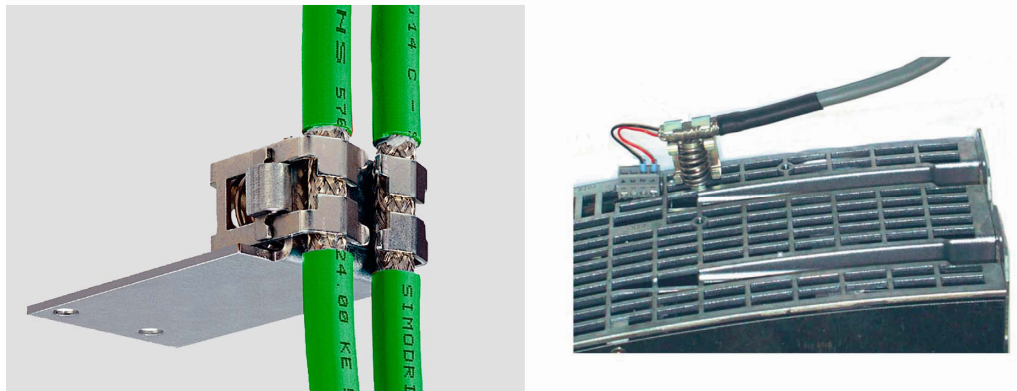

Figure 3-7 Examples of good types of shield connection

3.7 Laying cables on cable racks/routes at the plant

If cables cannot be routed directly from the control cabinet to the machine, they must be laid on cable racks/routes. In this case, all cable shields should also be connected at the cable entry of the control cabinet in order to comply with the immission limit values in the first environment. The shield connection is recommended for operation in the second environment.

The same requirements for the distance and shielding as described in Section General (Page 22) apply to the cable routing. The following figure shows a laying example.

3.7 Laying cables on cable racks/routes at the plant

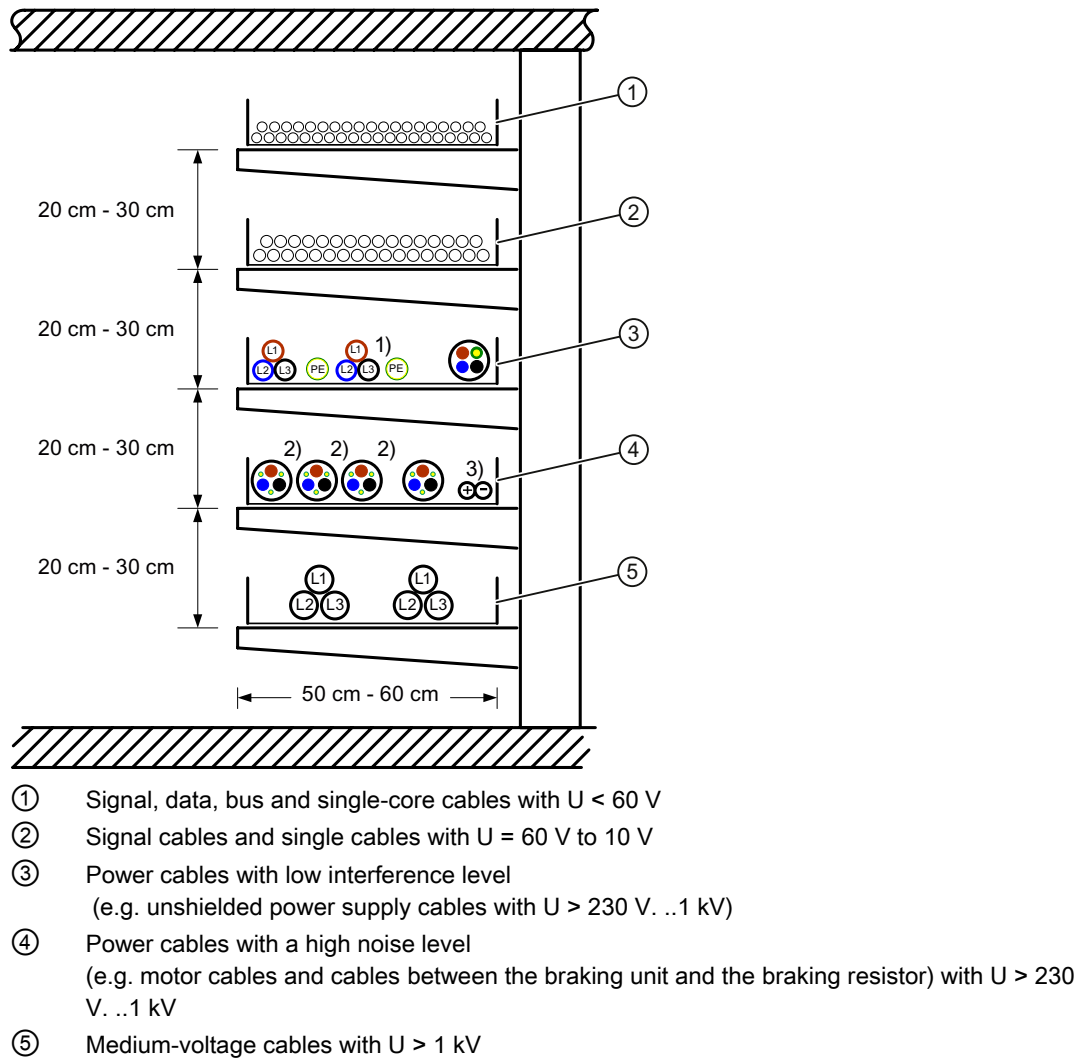

Figure 3-8 Cable installation

The cable racks/routes must be included in the equipotential bonding. In order to also achieve an effect in the high-frequency range, large surface area mechanical connections must be made to the cabinet and to the motor casing. The individual rack parts must also have a large surface area connection with each other.

For further information, see under
http://www.rittal.de/downloads/TechInfo/de/EMV_Praxis.pdf

3.8 Connection to the line supply

Equipment with converters also have low-frequency negative effects on the line supply that can be suppressed not at all or only to a very limited extent by the line filters. Such limited suppression can make itself apparent as flickering lights, overheating or even other defective devices, etc.

To prevent this, the connection conditions, such as the short-circuit power of the line supply and loop impedance, stated in the technical user documentation must be observed.

3.8.1 Drive line filter, cabinet line filter

The drive line filter that belongs to the converter system is tailored exclusively to the converter system and should only be used for this. For other consumers, a commercially available line filter should be installed as close as possible behind the main switch and fuse protection at the cabinet entry. Further consumers are supplied via this line filter.

To prevent the filter becoming ineffective because of over-coupling, the filtered cables must be laid with unfiltered cables in accordance with Section Drive line filter arrangement, line reactor, drive group (Page 32).

Filters must be installed as close as possible to the cable entry of the control cabinet with a large contact area. Exceptions are special drive filters that should be installed as close as possible to the drive group or filters integrated in devices, such as for SITOP power supplies. A large contact surface must be ensured during installation.

Incoming cables and filters to filter outgoing cables must always be installed separately. For examples, see Figure Good laying with distance (Page 32) and Figure Good laying with shield plate (Page 32).

Filtered and unfiltered cables must never be laid together.

3.8.2 Drive line filter arrangement, line reactor, drive group

Branching to the drive is made behind the main switch and the fuse protection but before the line filter. The housings of drive line filters and the infeed of the drive group must be connected together with low resistance for high-frequency interference currents. For this purpose, the components must be mounted close together on a common conducting (galvanized) mounting plate on which they must have a large-area, permanent conductive connection. The line reactor must be installed close to the filter and infeed.

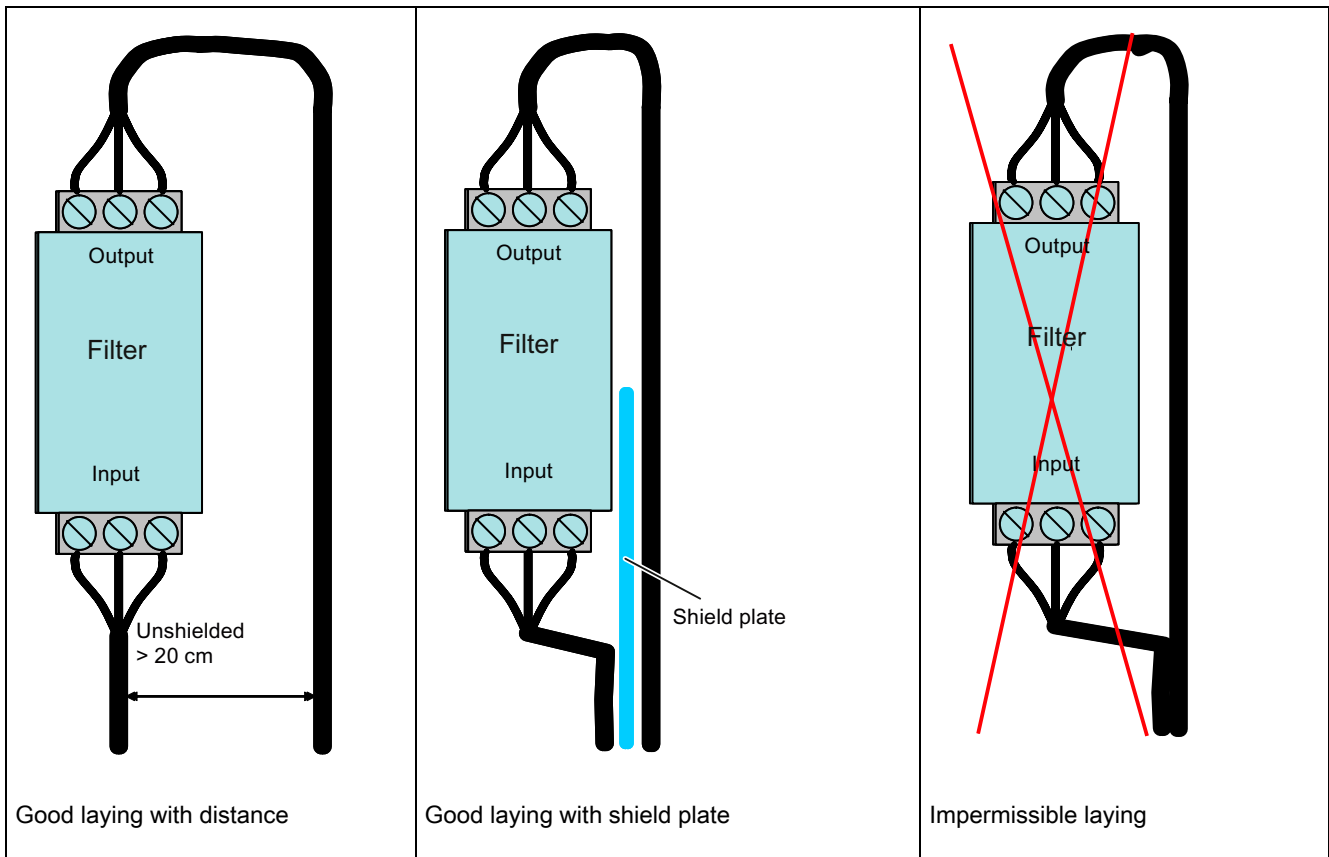

It is recommended that the power cables are laid shielded starting at the control cabinet inlet.

Note

Reactors and filters can also be combined, for example, as an AIM

3.9 Miscellaneous

3.9.1 Wiring of coils

When

- mechanical switch contacts are used for switching,
- unconnected PLC outputs are used for switching,

to avoid switching overvoltages, all connected actuators, contactor coils, solenoid valves, holding brakes, etc., should be connected using surge-suppression devices (e.g. RC elements, varistors), if possible, directly at the interference source.

NOTICE
Increased run times can occur for circuits with free-wheeling diodes.

3.9.2 Bearing currents

For converter operation, the motor voltages are generated by pulse-width modulation. The steep edges generate parasitic currents in the motor because of the winding capacitance. Some of these currents can flow through the motor bearings and so damage them. This can reduce the bearing service life.

Up to and including axis height 100, a good stator grounding by means of an EMC-compliant installation in accordance with the figure (see Figure 3-3 Grounding and high-frequency equipotential-bonding measures for equipotential bonding in the drive system via ground (Page 21)) must be provided over the shields of the cables [2] or an insulated coupling to ensure that the bearing currents are kept sufficiently small.

Above axis shaft height 100, an additional good high-frequency equipotential bonding to the driven machine and from the motor terminal box to the motor housing as shown in the figure (see Figure 3-3 Grounding and high-frequency equipotential-bonding measures for equipotential bonding in the drive system via ground (Page 21)) via the cables [5] is required and possibly an insulated bearing at the non-drive end.

du/dt or sine-wave filters can also be used at the converter output instead of an insulated bearing in the motor, provided this is permitted.

